



BORA MINI

ZANZARIERE
FLYSCREENS | MOSQUITERAS
MOUSTIQUAIRES | INSEKTENSCHUTZ

MV Line

BORA MINI



Cassonetto di avvolgimento
della rete: solo 32 mm

Winding box for the net:
only 32 mm

Coffre pour l'enroulement de
la toile: seulement 32 mm

Cajón de enrollado de la red:
solo 32 mm

Wickelkasten für das Netz:
nur 32 mm



Massima protezione e comfort per la tua casa, con un ingombro... mini!

BORA MINI è una zanzariera semplice ed elegante di rapida installazione, dotata di una struttura solida ma snella, con un cassonetto di avvolgimento della rete di soli 32 mm, dalle linee squadrate e moderne.

Il profilo maniglia, dal design ergonomico e lineare, è realizzato con un sistema innovativo brevettato che rende la movimentazione agevole ed efficace, ottenendo uno scorrimento laterale dolce e fluido.

Non teme sollecitazioni esterne o atmosferiche critiche: **BORA MINI** ha un sistema brevettato che impedisce la fuoriuscita della rete (anche sull'estremità superiore) e una chiusura tramite magnete che ne previene l'apertura accidentale in caso di vento forte.

BORA MINI è perfetta su finestre e porte-finestre, con una larghezza realizzabile fino a 140 cm e una guida di scorrimento a pavimento che non ostacola l'attraversamento (lo spessore è inferiore a 2 mm!).

La zanzariera **BORA MINI** è disponibile in una ricca gamma di colori e con diverse varianti di tinta anche per i componenti plastici a vista, garantendo un ottimo abbinamento con i tuoi infissi.



Maximum protection and comfort for your home, with minimal space!

BORA MINI is a simple and elegant flyscreen with quick installation, equipped with a sturdy yet slim structure, featuring a winding box for the net that is only 32 mm, with square and modern lines.

The handle profile, with ergonomic and linear design, is made with an innovative patented system that makes handling easy and effective, achieving smooth and fluid lateral sliding.

It doesn't fear external stresses or critical weather conditions: **BORA MINI** has a patented system that prevents the net from coming out (even at the upper end) and a magnetic closure that prevents accidental opening in case of strong wind.

BORA MINI is perfect for windows and French doors, with a width achievable up to 140 cm and a floor sliding guide that does not hinder passage (thickness is less than 2 mm!).

BORA MINI is available in a rich range of colors and with different tint variants for visible plastic components, ensuring an excellent match with your fixtures.



Une protection maximale et un confort optimal pour votre maison, avec un encombrement minimal!

BORA MINI est une moustiquaire simple et élégante à installation rapide, équipée d'une structure robuste mais fine, avec un coffre pour l'enroulement de la toile de seulement 32 mm, aux lignes carrées et modernes.

La barre de charge, au design ergonomique et linéaire, est réalisée avec un système innovant breveté qui facilite l'actionnement et permet un glissement latéral doux et fluide.

Elle ne craint pas les sollicitations externes ou les conditions météorologiques critiques: **BORA MINI** est doué d'un système breveté qui empêche la sortie de la toile (même à l'extrémité supérieure) et d'une fermeture magnétique qui prévient une ouverture accidentelle en cas de vent fort.

BORA MINI est parfaite pour les fenêtres et les portes-fenêtres, avec une largeur qui peut arriver jusqu'à 140 cm et un rail bas qui n'entrave pas le passage (l'épaisseur est inférieure à 2 mm!).

La moustiquaire **BORA MINI** est disponible dans une large gamme de couleurs et avec différentes variantes de teintes même pour les composants en plastiques visibles, garantissant une excellente harmonie avec vos menuiseries.



BORA MINI



¡ Máxima protección y comodidad para tu hogar con un espacio mínimo!

BORA MINI es una mosquitera simple y elegante de instalación rápida. La estructura es sólida y delgada con un cajón de enrollado de la red de 32 mm, de líneas cuadradas y modernas.

El perfil del mango, con un diseño ergonómico y lineal, está fabricado con un sistema innovador patentado que facilita el manejo y logra un deslizamiento lateral fluido.

No teme las tensiones externas ni las condiciones climáticas críticas: **BORA MINI** tiene un sistema patentado que evita que la red salga (incluso en la parte superior) y un cierre magnético que evita la apertura accidental en caso de viento fuerte.

BORA MINI es perfecta para ventanas y puertas, con un ancho alcanzable de hasta 140 cm y una guía de deslizamiento en el suelo que no obstaculiza el paso (¡el grosor es inferior a 2 mm!).

La mosquitera **BORA MINI** está disponible en una amplia gama de colores y con diferentes variantes de tonalidades incluso para los componentes plásticos visibles, garantizando una excelente combinación con tus accesorios.



Maximaler Schutz und Komfort für Ihr Zuhause, bei minimalem Platzbedarf!

BORA MINI ist ein einfaches und elegantes Fliegengitter mit schneller Installation, ausgestattet mit einer robusten, aber schlanken Struktur und einem Wickelkasten für das Netz von nur 32 mm, mit rechteckigen und modernen Linien.

Das Griffprofil, mit ergonomischem und linearem Design, ist mit einem innovativen patentiertes System ausgestattet, das die Bewegung leicht und effektiv macht und ein sanftes und flüssiges seitliches Gleiten ermöglicht.

Es fürchtet keine äußeren Belastungen oder kritischen Wetterbedingungen: **BORA MINI** verfügt über ein patentiertes System, das der Auftritt des Netzes verhindert (auch an der oberen Endseite) und einen Magnetverschluss, der ein unbeabsichtigtes Öffnen bei starkem Wind verhindert.

BORA MINI eignet sich perfekt für Fenster und Fenstertüren, mit einer Breite von bis zu 140 cm und einer Bodenschienenführung, die den Durchgang nicht behindert (die Dicke beträgt weniger als 2 mm!).

Die **BORA MINI** ist in einer reichen Farbpalette und mit verschiedenen Farbvarianten verfügbar. Die Zubehöre aus Plastik sind auch in verschiedenen Farben erhältlich, damit einer optimalen Anpassung an Ihre Fenster garantiert wird.





Si installa facilmente

Easy installation

Installation facile

Fácil instalación

Einfache installation



Scorrimento fluido

Smooth sliding

Deroulement fluide

Deslizamiento suave

Sanftes gleiten



BORA MINI



Grazie a un sistema brevettato, la rete non fuoriesce dalle guide

Thanks to a patented system, the net does not come out of the guides

Grâce à un système breveté, la toile ne sort pas des coulisses

Gracias a un sistema patentado, la red no sale de las guías

Dank eines patentierten Systems tritt das Netz nicht aus den Führungen aus



Ingombro ridotto

Small size

Encombrement réduit

Espacio reducido

Reduzierter Raumbedarf



Larghezza massima fino a 140 cm

Maximum width up to 140 cm

Largeur maximale jusqu'à 140 cm

Ancho máximo de hasta 140 cm,

Maximale Breite bis zu 140 cm

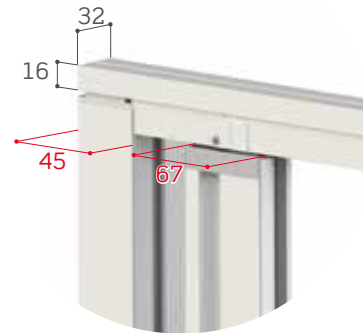

LISTINO | PRICE LIST | PRIX | TARIFA | PREISLISTE 2024

RETE NET TOILE RED NETZ	BASE RAL SOFT	RAFFAELLO OSSIDATE SABLÈ	LEGNO
BLACKLINE			
FIBRA FIBER FIBRE GLASFASERNETZ	€ 164,30	€ 188,95	€ 213,60
MINIMO FATTURABILE MINIMUM ORDER VALUE MINIMUM FACTURABLE MINDEST-GRÖSSE			2,0 m²





COLORI DISPONIBILI

AVAILABLE COLORS

COULEURS DISPONIBLES

COLORES DISPONIBLES

VERFÜGBARE FARBEN



















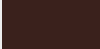





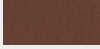

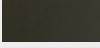



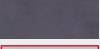







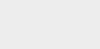







COLOR LINE: Per le tinte indicate in rosso sono disponibili gli accessori a colore in abbinamento.

For the colours highlighted in red, matching colour accessories are available.

Pour les couleurs indiquées en rouge les accessoires sont disponibles en combinaison de la même couleur.

Para los colores evidenciados en rojo están disponibles los accesorios con el color en combinación.

Für die in Rot hervorgehobenen Farbtöne ist passendes Zubehör verfügbar.

RAL	SOFT	RAFFAELLO	LEGNO
 9010	 9001 SOFT	 GRIGIO RAFFAELLO	 NOCE EFFECTA
 1013	 6005 SOFT	 VERDE RAFFAELLO	 NOCE 100
 8017	 8014 SOFT	 MARRONE RAFFAELLO	 NOCE 100 R
 NERO	 8017 SOFT	 TESTA DI MORO MV	 RENOLIT CHIARO
 TESTA DI MORO 9900	 7001 SOFT		 RENOLIT SCURO
 ARGENTO VERNICIATO	 7012 SOFT	OSSIDATE	 PINO 1
 BRONZO VERNICIATO	 7032 SOFT	 TITANIO	 CILIEGIO CON FIAMMA
 BRONZO SCURO VERNICIATO	 BIANCO SOFT	 BRONZO SCURO OSS.	 CILIEGIO CON FIAMMA R
 7016	 7016 SOFT	SABLÈ	 CILIEGIO ATLANTICO R
 3005	 1013 SOFT	 NOIR SABLÈ	 NOCE 101 R
 6009	 9016 SOFT	 CORTEN SABLÈ	 CASTANO C 378 R
 7022			 OLMO CHIARO R
 9006 OPACO			 OLMO SCURO R
			 RENOLIT BIANCO

Per ulteriori informazioni su come ordinare e sui colori disponibili consultare il catalogo.

For further information on how to order and available colors, please refer to the catalog. | Pour plus d'informations sur la commande et les couleurs disponibles, veuillez consulter le catalogue. | Para obtener más información sobre cómo hacer un pedido y los colores disponibles, consulte el catálogo. | Für weitere Informationen zur Bestellung und den verfügbaren Farben, konsultieren Sie bitte den Katalog.



Il bello di sentirsi protetti.



mvline.it • installatore@mvline.it